

Equipment Pictorial
Model 1032B Classic® Splice Detector™ Technology

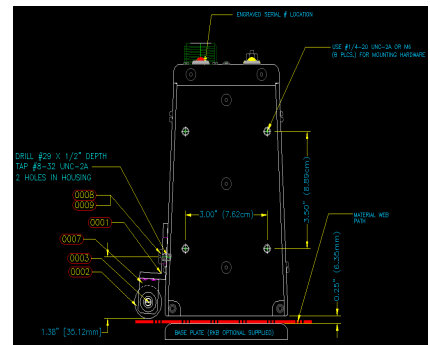
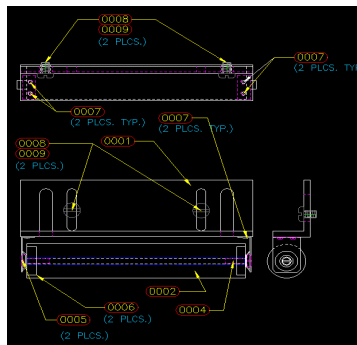
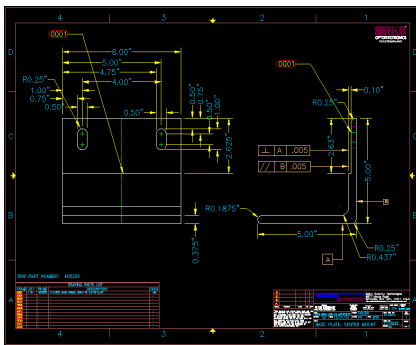
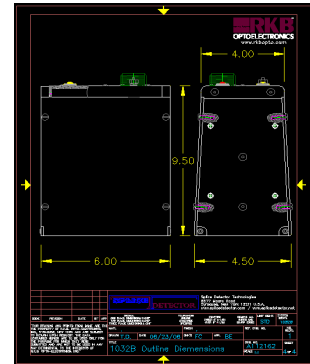
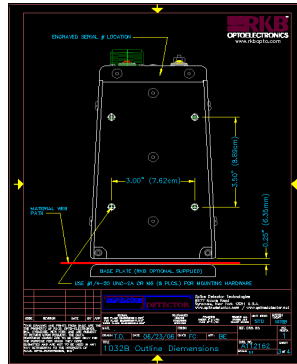
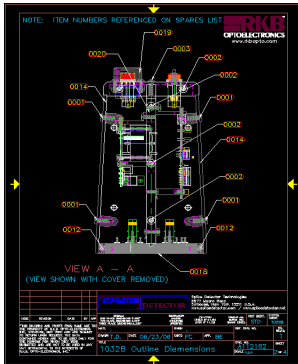
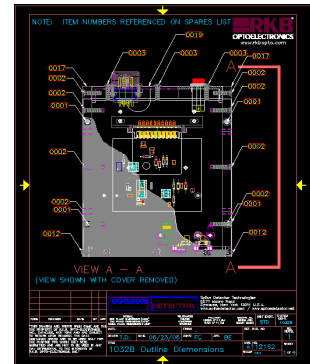
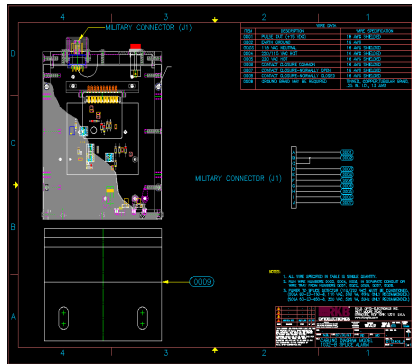

R.K.B. OPTO-ELECTRONICS, INC.

6677 Moore Road • Syracuse, New York • 13211 • United States of America

Tel: +001-315-455-6636 • Fax: +001-315-455-8216 • Email: sales@spicedetector.com

Internet: www.rkbopto.com / www.spicedetector.com / www.spicedetector.net



Model 1032B Classic® Splice Detector™ Coater Install

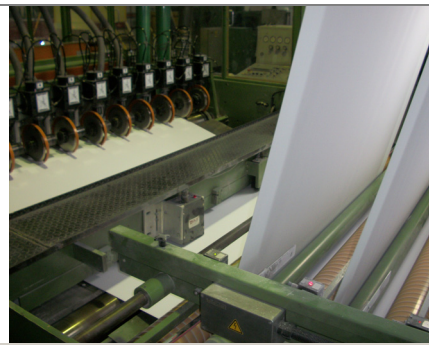

Model 1032B Classic® Splice Detector™ ECH Will Install

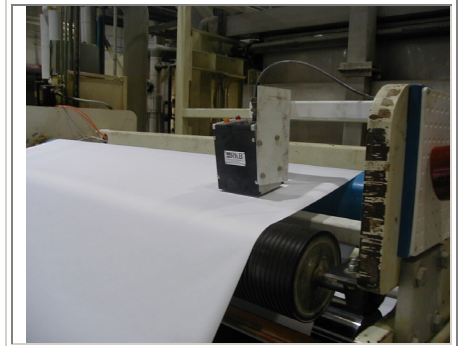

Model 1032B Classic® Splice Detector™ Coater Install



Model 1032B Classic® Splice Detector™ Laminator Install



Model 1032B Classic® Splice Detector™ MWU Install

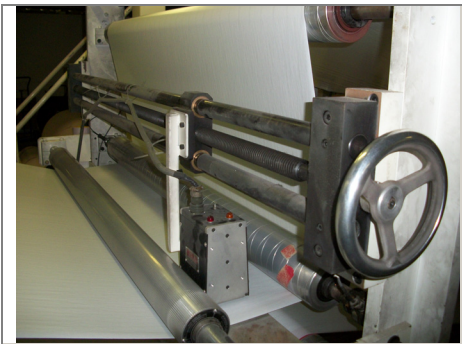

Model 1032B Classic® Splice Detector™ Laminator Install



Model 1032B Classic® Splice Detector™ Web Press Install



Model 1032B Classic® Splice Detector™ Jagenberg Install



Model 1032B Classic® Splice Detector™ Coater Install

R.K.B. OPTO-ELECTRONICS, INC.

6677 Moore Road • Syracuse, New York • 13211 • United States of America
Tel: +001-315-455-6636 • Fax: +001-315-455-8216 • Email: sales@splicedetector.com
Internet: www.rkbopto.com / www.splicedetector.com / www.splicedetector.net



Model 1032B Classic® Splice Detector™ Laminator Install



Model 1032B Classic® Splice Detector™ MWU Install



Model 1032B Classic® Splice Detector™ Coater Install



Model 1032B Classic® Splice Detector™ USA Install

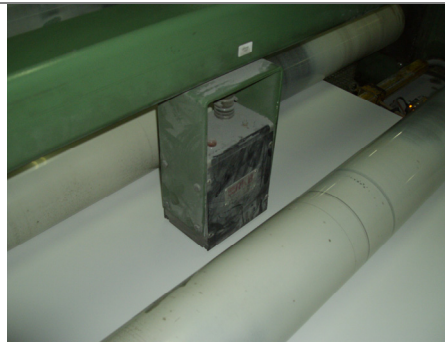

Model 1032B Classic® Splice Detector™ Spain Install



Model 1032B Classic® Splice Detector™ German Install



Model 1032B Classic® Splice Detector™ USA Install

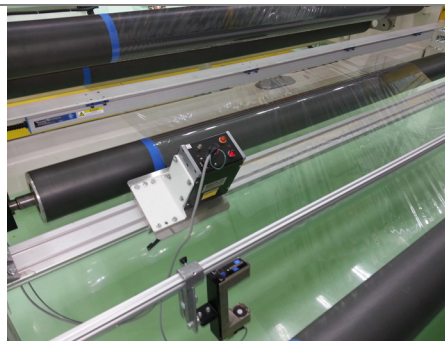

Model 1032B Classic® Splice Detector™ China Install



Model 1032B Classic® Splice Detector™ Australia Install

R.K.B. OPTO-ELECTRONICS, INC.

6677 Moore Road • Syracuse, New York • 13211 • United States of America
Tel: +001-315-455-6636 • Fax: +001-315-455-8216 • Email: sales@splicedetector.com
Internet: www.rkbopto.com / www.splicedetector.com / www.splicedetector.net



Model 1032B Classic® Splice Detector™ Indonesia Install



Model 1032B Classic® Splice Detector™ France Install



Model 1032B Classic® Splice Detector™ German Install



Model 1032B Classic® Splice Detector™ Europe Install

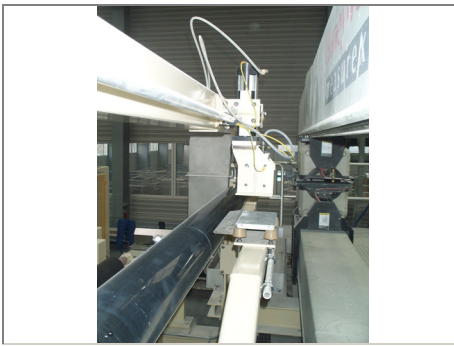

Model 1032B Classic® Splice Detector™ Poland Install



Model 1032B Classic® Splice Detector™ China Install



Model 1032B Classic® Splice Detector™ USA Install

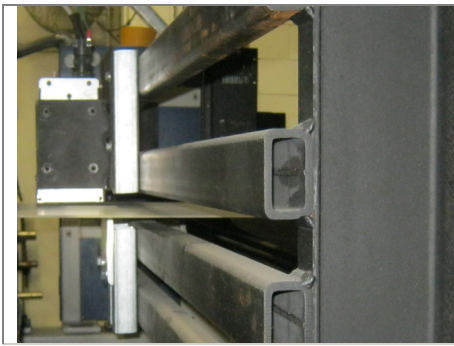

Model 1032B Classic® Splice Detector™ USA Install



Model 1032B Classic® Splice Detector™ India Install

R.K.B. OPTO-ELECTRONICS, INC.

6677 Moore Road • Syracuse, New York • 13211 • United States of America
Tel: +001-315-455-6636 • Fax: +001-315-455-8216 • Email: sales@splicedetector.com
Internet: www.rkbopto.com / www.splicedetector.com / www.splicedetector.net