

## Equipment Pictorial Model 1088BM Black Mamba® Web Press Splice Detector™ & Distribution Technology

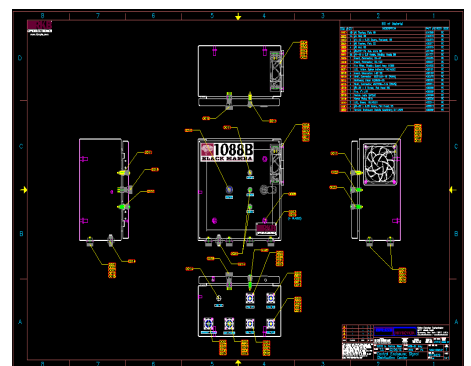
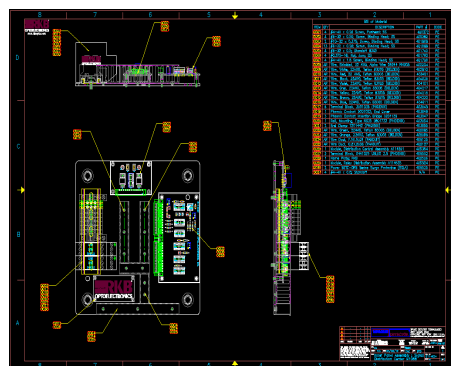
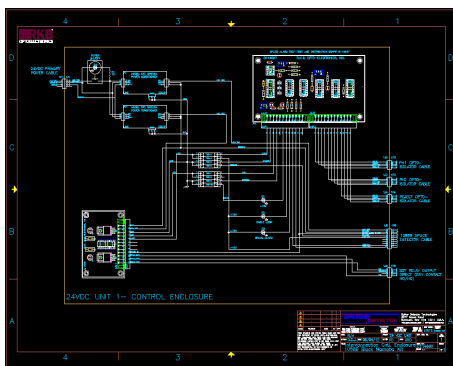
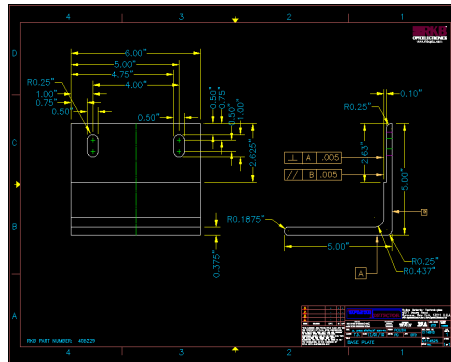
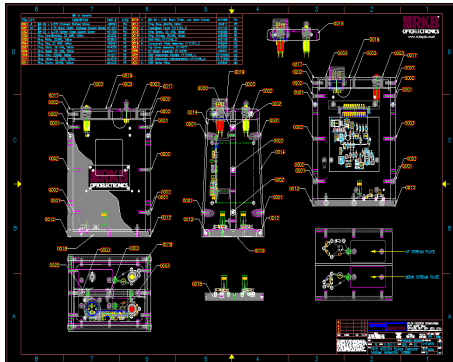
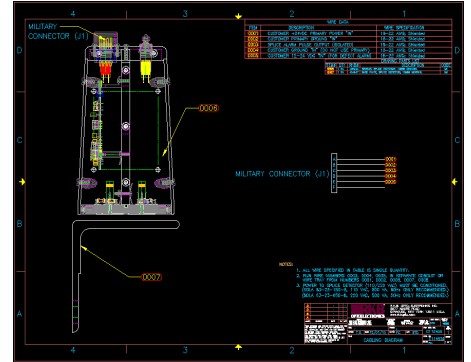
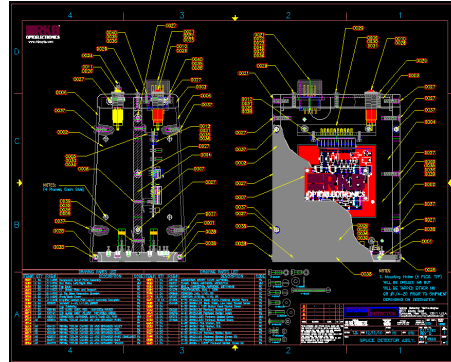
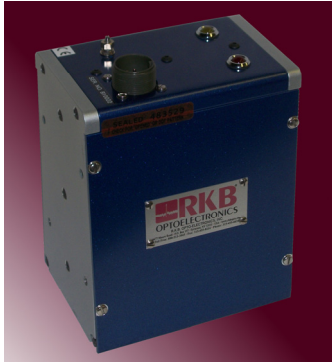

**R.K.B. OPTO-ELECTRONICS, INC.**

6677 Moore Road • Syracuse, New York • 13211 • United States of America

Tel: +001-315-455-6636 • Fax: +001-315-455-8216 • Email: sales@spicedetector.com

Internet: www.rkbopto.com / www.spicedetector.com / www.spicedetector.net

# Splice Detection Technology - 1088 Series

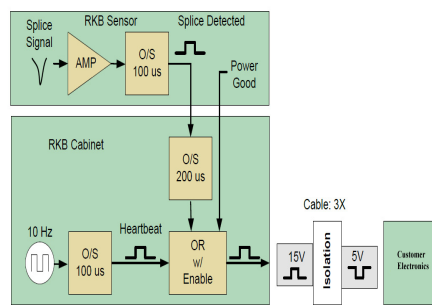
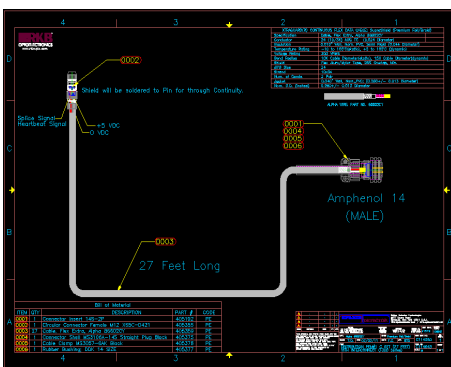
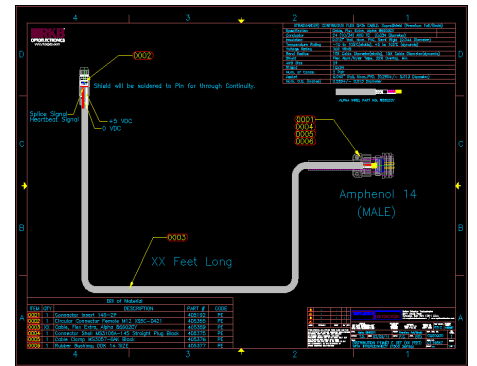
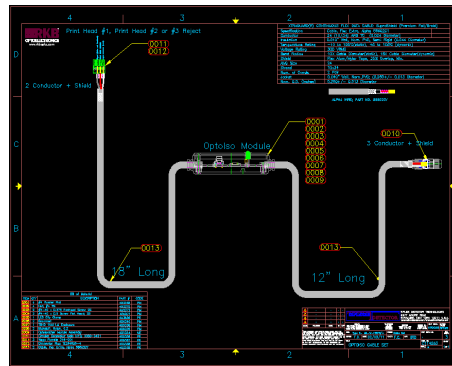
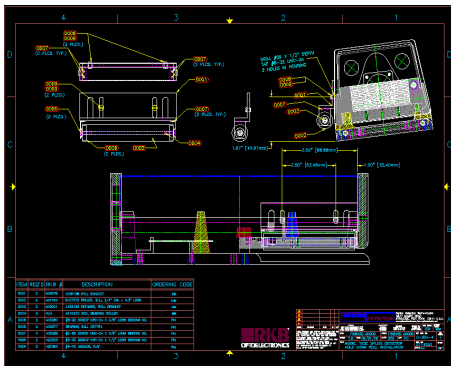
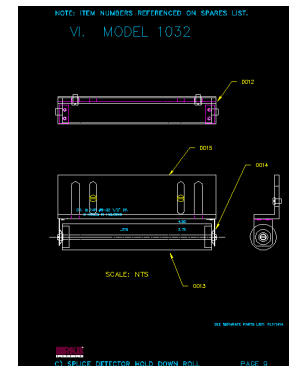
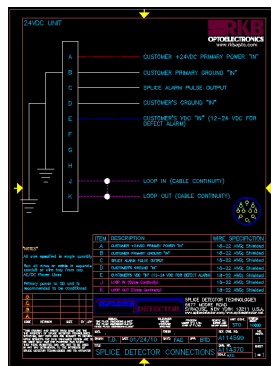
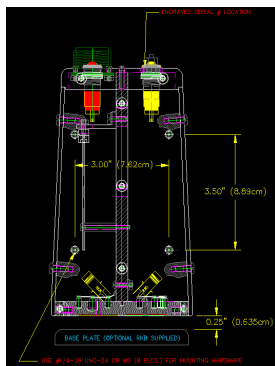
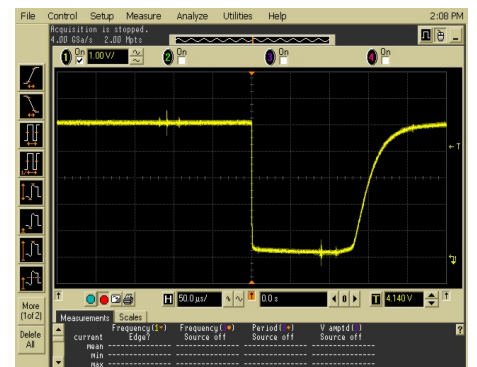

Figure 1: RKB System Block Diagram



## R.K.B. OPTO-ELECTRONICS, INC.

6677 Moore Road • Syracuse, New York • 13211 • United States of America  
 Tel: +001-315-455-6636 • Fax: +001-315-455-8216 • Email: sales@spicedetector.com  
 Internet: www.rkbopto.com / www.spicedetector.com / www.spicedetector.net

SPLICE DETECT ON T400

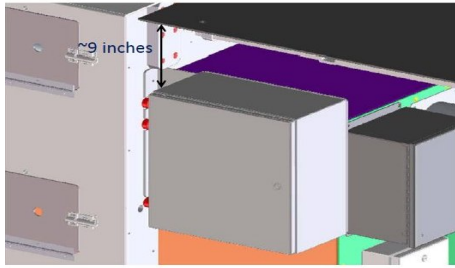

Control Box location

SPLICE DETECT ON T400

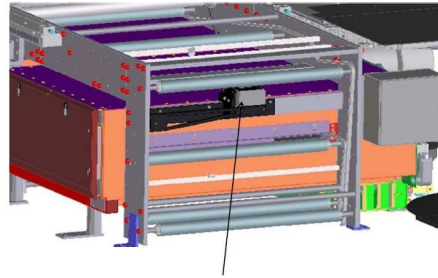

Located on the in-feed on PEM1

SPLICE DETECT ON T400

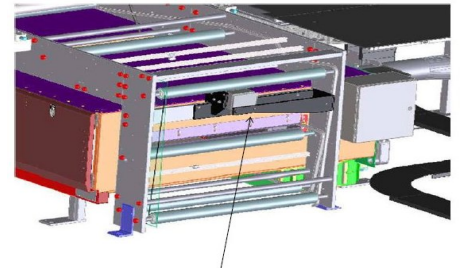

Located on the in-feed on PEM1

SPLICE DETECT ON T400

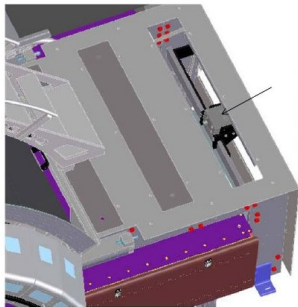

Access (if necessary, but no adjustment/maintenance is normally required).

SPLICE DETECT ON T400

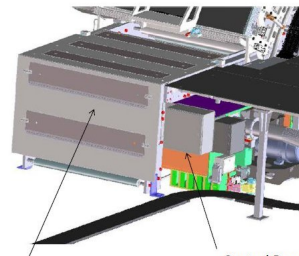

Detector located inside the cover on the in-feed on PEM1

Control Box location

SPLICE DETECT ON T400

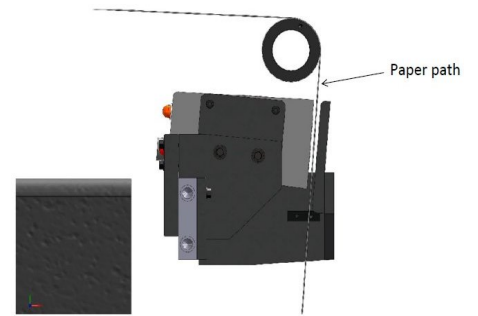

Paper path



**R.K.B. OPTO-ELECTRONICS, INC.**

6677 Moore Road • Syracuse, New York • 13211 • United States of America

Tel: +001-315-455-6636 • Fax: +001-315-455-8216 • Email: sales@splicedetector.com

Internet: www.rkbopto.com / www.splicedetector.com / www.splicedetector.net

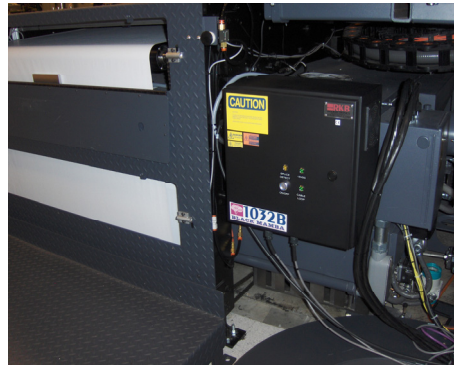
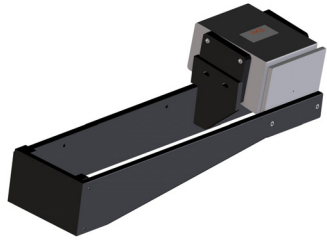

SPLICE DETECT ON T400



Detector located inside the cover on the in-feed on PEM1

Control Box location

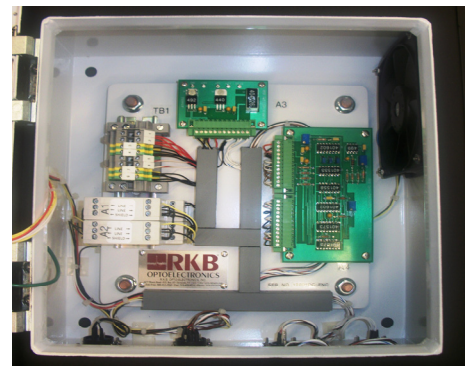

**R.K.B. OPTO-ELECTRONICS, INC.**

6677 Moore Road • Syracuse, New York • 13211 • United States of America  
Tel: +001-315-455-6636 • Fax: +001-315-455-8216 • Email: sales@splicedetector.com  
Internet: www.rkbopto.com / www.splicedetector.com / www.splicedetector.net