

**EQUIPMENT PICTORAL**  
**Model 1280 Guardian® Multicolor Edge Marking™ Technology**

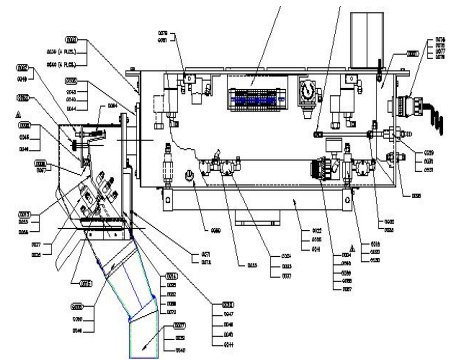

**R.K.B. OPTO-ELECTRONICS, INC.**

6677 Moore Road • Syracuse, New York • 13211 • United States of America  
Tel: +001-315-455-6636 • Fax: +001-315-455-8216 • Email: sales@splicedetector.com  
Internet: www.rkbopto.com / www.splicedetector.com / www.splicedetector.net

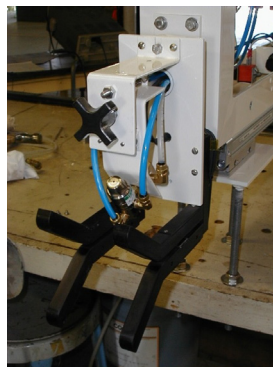
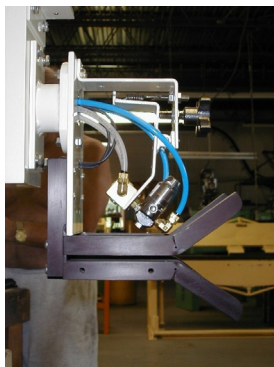
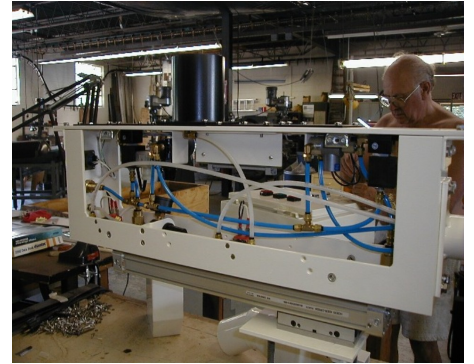
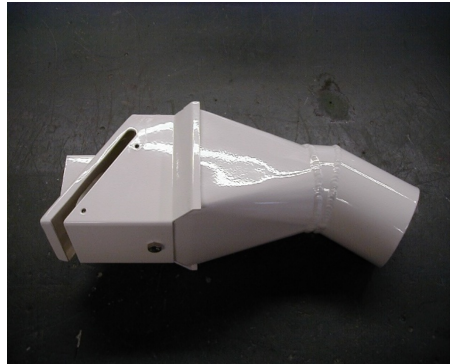
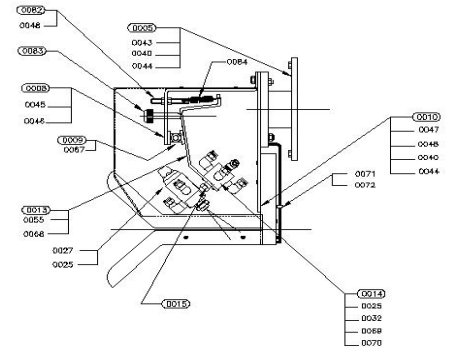
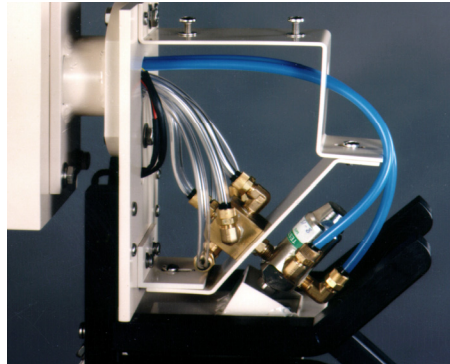

**R.K.B. OPTO-ELECTRONICS, INC.**

6677 Moore Road • Syracuse, New York • 13211 • United States of America  
Tel: +001-315-455-6636 • Fax: +001-315-455-8216 • Email: sales@splicedetector.com  
Internet: www.rkbopto.com / www.splicedetector.com / www.splicedetector.net



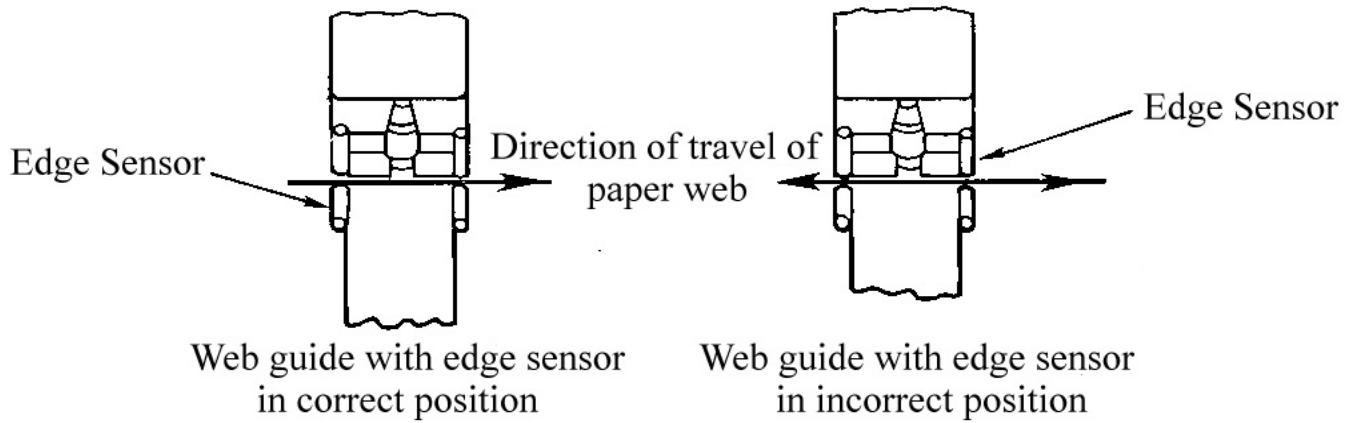

**R.K.B. OPTO-ELECTRONICS, INC.**

6677 Moore Road • Syracuse, New York • 13211 • United States of America  
Tel: +001-315-455-6636 • Fax: +001-315-455-8216 • Email: sales@splicedetector.com  
Internet: www.rkbopto.com / www.splicedetector.com / www.splicedetector.net