

EQUIPMENT PICTORAL Model 1280 Guardian® Multicolor Edge Marking™ Technology

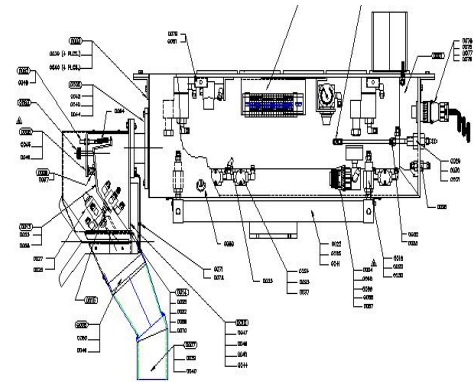
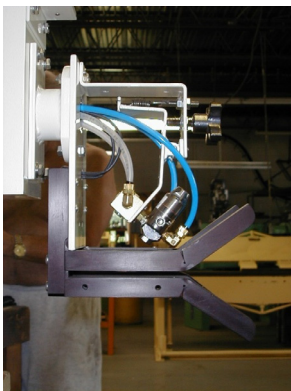
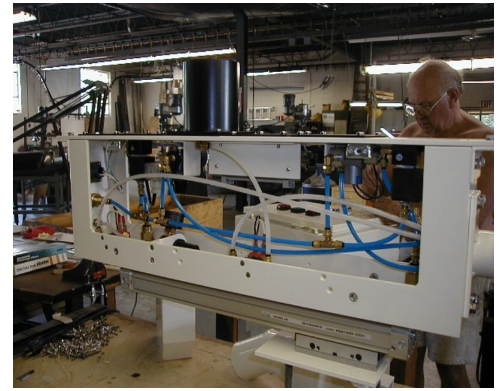
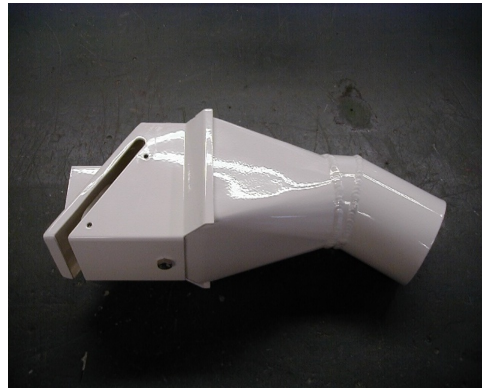
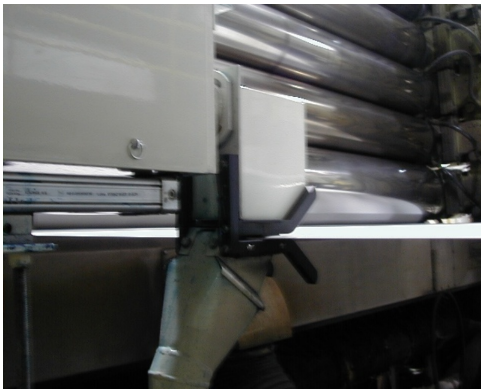
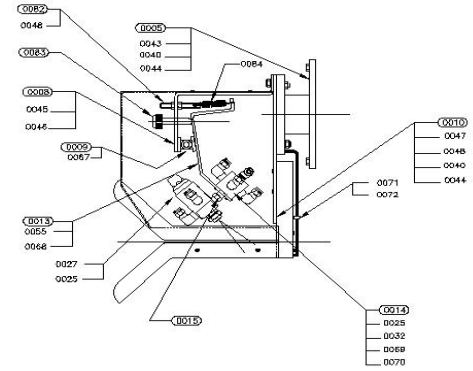
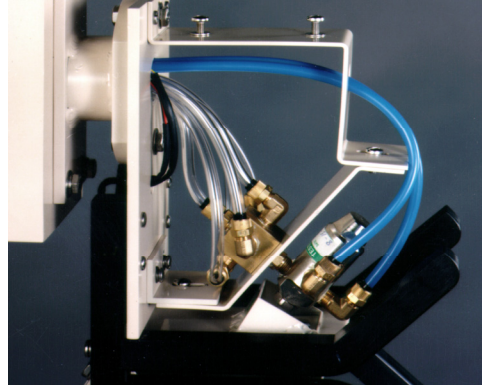

R.K.B. OPTO-ELECTRONICS, INC.

6677 Moore Road • Syracuse, New York • 13211 • United States of America

Tel: +001-315-455-6636 • Fax: +001-315-455-8216 • Email: sales@splicedetector.com

Internet: www.rkbopto.com / www.splicedetector.com / www.splicedetector.net

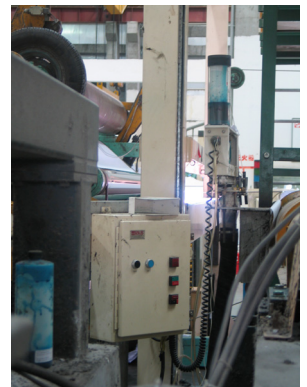

R.K.B. OPTO-ELECTRONICS, INC.

6677 Moore Road • Syracuse, New York • 13211 • United States of America
Tel: +001-315-455-6636 • Fax: +001-315-455-8216 • Email: sales@splicedetector.com
Internet: www.rkbopto.com / www.splicedetector.com / www.splicedetector.net

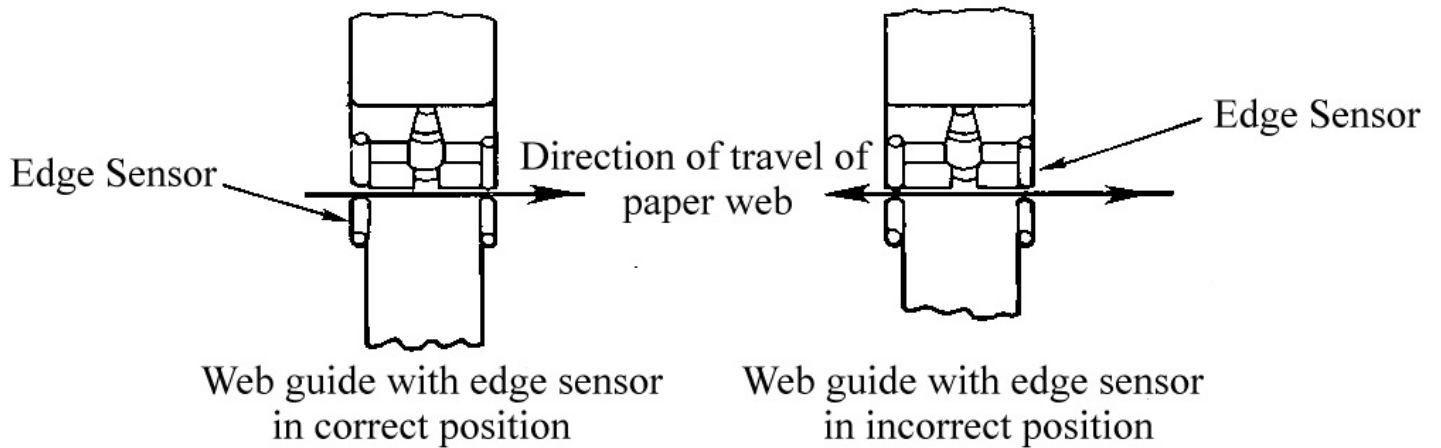
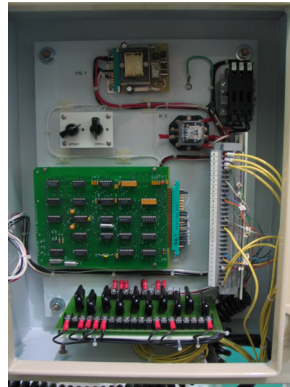

R.K.B. OPTO-ELECTRONICS, INC.

6677 Moore Road • Syracuse, New York • 13211 • United States of America
Tel: +001-315-455-6636 • Fax: +001-315-455-8216 • Email: sales@splicedetector.com
Internet: www.rkbopto.com / www.splicedetector.com / www.splicedetector.net